

LCD Module Specification

First Edition

May 7, 1997

Final Revision

Approved by Production Div.

Checked by Quality Assurance Div.

Checked by Design Engineering Div.

Prepared by Production Div.

Type No. **DMC 1 6 1 8 8 NY - LY**

Table of Contents

| | |
|--|----|
| 1. General Specifications | 2 |
| 2. Electrical Specifications..... | 3 |
| 3. Optical Specifications | 6 |
| 4. I/O Terminal..... | 8 |
| 5. Test..... | 10 |
| 6. Appearance Standards..... | 11 |
| 7. Code System of Production Lot | 14 |
| 8. Type Number | 14 |
| 9. Applying Precautions | 14 |
| 10. Handling Precautions | 15 |

Revision History

| Rev. | Date | Page | Comment |
|------|------|------|---------|
| | | | |



1. General Specifications

| | |
|--------------------|--|
| Operating Temp. | : min. 0°C ~ max. 50°C |
| Storage Temp. | : min. -20°C ~ max. 70°C |
| Display Format | : 16 characters × 1 line |
| Display Fonts | : 5 × 8 dots (1 character) |
| Viewing Area | : 120.0 (W) × 23.0 (H) mm |
| Outline Dimensions | : 151.0 (W) × 40.0 (H) × 14.2 (D) mm |
| Weight | : 40g max. |
| LCD Type | : NTD-7316 (STN / Yellow-mode / Transmissive) |
| Viewing Angle | : 6:00 |
| Backlight | : LED Backlight / Yellow-green |
| Drawings | : Dimensional Outline UE-31545 |

2. Electrical Specifications

2.1. Absolute Maximum Ratings

V_{SS}=0V

| Parameter | Symbol | Conditions | Min. | Max. | Units |
|-------------------------------|----------------------------------|------------|------|----------------------|-------|
| Supply Voltage (Logic) | V _{CC} -V _{SS} | — | -0.3 | 7.0 | V |
| Supply Voltage (LCD Drive) | V _{CC} -V _{EE} | — | 0 | 13.0 | V |
| Input Voltage | V _I | — | -0.3 | V _{CC} +0.3 | V |

2.2. DC Characteristics

T_a=25°C, V_{SS}=0V

| Parameter | Symbol | Conditions | Min. | Typ. | Max. | Units |
|-------------------------------|----------------------------------|--|------|------|-----------------|-------|
| Supply Voltage (Logic) | V _{CC} -V _{SS} | — | 4.5 | — | 5.5 | V |
| Supply Voltage (LCD Drive) | V _{CC} -V _{EE} | Shown in 3.1 | | | | V |
| High Level Input Voltage | V _{IH} | V _{CC} =5.0V ± 10% | 2.2 | — | V _{CC} | V |
| Low Level Input Voltage | V _{IL} | V _{CC} =5.0V ± 10% | 0 | — | 0.6 | V |
| High Level Output Voltage | V _{OH} | I _{OH} =-0.205mA | 2.4 | — | V _{CC} | V |
| Low Level Output Voltage | V _{OL} | I _{OL} =1.2mA | 0 | — | 0.4 | V |
| Supply Current | I _{CC} | V _{CC} -V _{SS} =5.0V | — | 1.7 | 5.0 | mA |

2.3.AC Characteristics

$V_{CC}=5.0V \pm 10\%$

| Parameter | Symbol | Conditions | Min. | Max. | Units |
|-----------------------|------------------|------------|------|------|-------|
| Enable Cycle Time | t_{CYC} | Fig.1, 2 | 500 | — | ns |
| Enable Pulse Width | P_{WEH} | Fig.1, 2 | 230 | — | ns |
| Enable Rise/Fall Time | t_{Er}, t_{Ef} | Fig.1, 2 | — | 20 | ns |
| Address Setup Time | t_{AS} | Fig.1, 2 | 40 | — | ns |
| Address Hold Time | t_{AH} | Fig.1, 2 | 10 | — | ns |
| Write Data Setup Time | t_{DSW} | Fig.1 | 80 | — | ns |
| Write Data Hold Time | t_{DHW} | Fig.1 | 10 | — | ns |
| Read Data Delay Time | t_{DDR} | Fig.2 | — | 160 | ns |
| Read Data Hold Time | t_{DHR} | Fig.2 | 5 | — | ns |



Fig.1 Write Operation Timing



Fig.2 Read Operation Timing

2.4. Lighting Specifications

2.4.1. Absolute Maximum Ratings

Ta=25°C

| Parameter | Symbol | Conditions | Min. | Typ. | Max. | Units |
|-----------------------|----------------|------------|------|------|------|-------|
| Forward Current | I _F | Note 1 | — | — | 600 | mA |
| Reverse Voltage | V _R | — | — | — | 8 | V |
| LED Power Dissipation | P _D | — | — | — | 260 | mW |

Note 1 : Refer to the forward current derating curve.

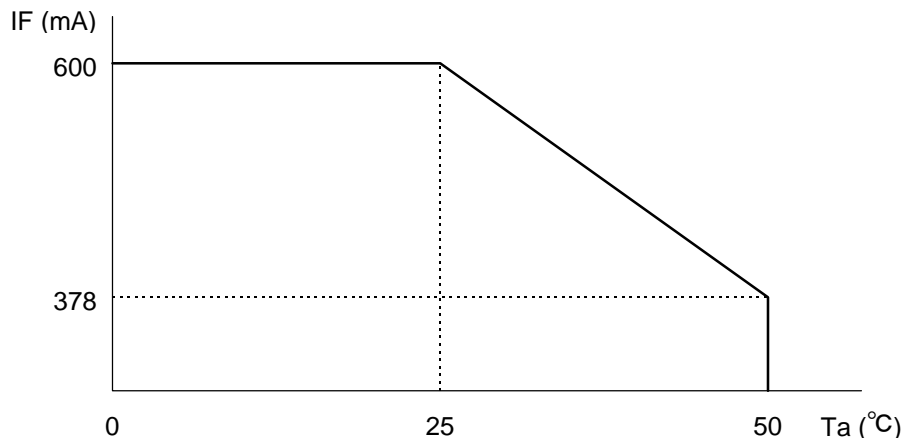

2.4.2. Operating Characteristics

Ta=25°C

| Parameter | Symbol | Conditions | Min. | Typ. | Max. | Units |
|--------------------------------|----------------|-----------------------|------|------|------|-------------------|
| Forward Voltage | V _F | I _F =300mA | 3.8 | 4.0 | 4.2 | V |
| Luminance of Backlight Surface | L | I _F =300mA | 50 | — | — | cd/m ² |

3. Optical Specifications

3.1. LCD Driving Voltage

| Parameter | Symbol | Conditions | Min. | Typ. | Max. | Units |
|--|-----------------|--------------------------|------|------|------|-------|
| Recommended LCD Driving Voltage Note 1 | $V_{CC}-V_{EE}$ | $T_a=0^{\circ}\text{C}$ | — | — | 4.2 | V |
| | | $T_a=25^{\circ}\text{C}$ | 3.4 | 3.7 | 4.0 | V |
| | | $T_a=50^{\circ}\text{C}$ | 3.3 | — | — | V |

Note 1 : Voltage (Applied actual waveform to LCD Module) for the best contrast. The range of minimum and maximum shows tolerance of the operating voltage. The specified contrast ratio and response time are not guaranteed over the entire range.

3.2. Optical Characteristics

$T_a=25^{\circ}\text{C}$, 1/8 Duty, 1/4 Bias, $V_D=3.7\text{V}$ (Note 4), $\theta = 0^{\circ}$, $\phi = -^{\circ}$

| Parameter | Symbol | Conditions | Min. | Typ. | Max. | Units |
|--------------------------|-----------------|---|------|------|------|-------|
| Contrast Ratio Note 1 | CR | $\theta = 0^{\circ}$, $\phi = -^{\circ}$ | — | 8 | — | |
| Viewing Angle | | Shown in 3.3 | | | | |
| Response Time | Rise Note 2 | τ | — | 65 | 130 | ms |
| | Decay Note 3 | τ_d | — | 170 | 260 | ms |

Note 1 : Contrast ratio is defined as follows.

$$\text{CR} = L_{\text{OFF}} / L_{\text{ON}}$$

L_{ON} : Luminance of the ON segments

L_{OFF} : Luminance of the OFF segments

Note 2 : The time that the luminance level reaches 90% of the saturation level from 0% when ON signal is applied.

Note 3 : The time that the luminance level reaches 10% of the saturation level from 100% when OFF signal is applied.

Note 4 : Definition of Driving Voltage V_D

Assuming that the typical driving waveforms shown below are applied to the LCD Panel at 1/A Duty - 1/B Bias (A : Duty Number, B : Bias Number). Driving voltage V_D is defined as follows.

$$V_D = (V_{th1} + V_{th2}) / 2$$

V_{th1} : The voltage V_{O-P} that should provide 50% of the saturation level in the luminance at the segment which the ON signal is applied to.

V_{th2} : The voltage V_{O-P} that should provide 50% of the saturation level in the luminance at the segment which the OFF signal is applied to.

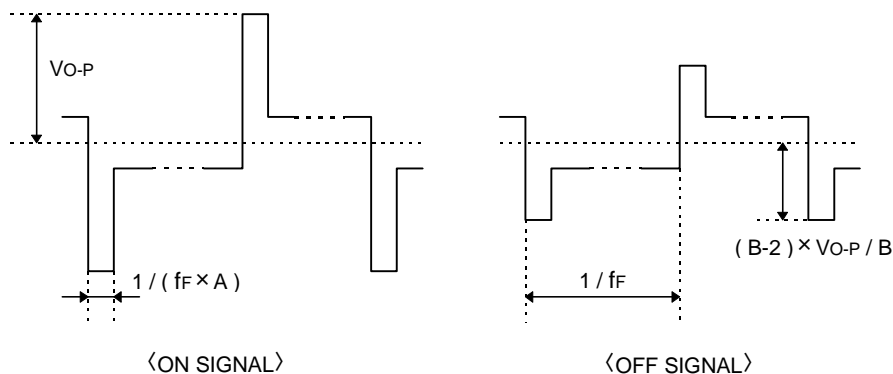

3.3. Definition of Viewing Angle and Optimum Viewing Area

- Point ● shows the point where contrast ratio is measured. : $\theta = 0^\circ$, $\phi = -^\circ$
- Driving condition : 1/8 Duty, 1/4 Bias, $V_D=3.7V$, $f_F=78.1Hz$

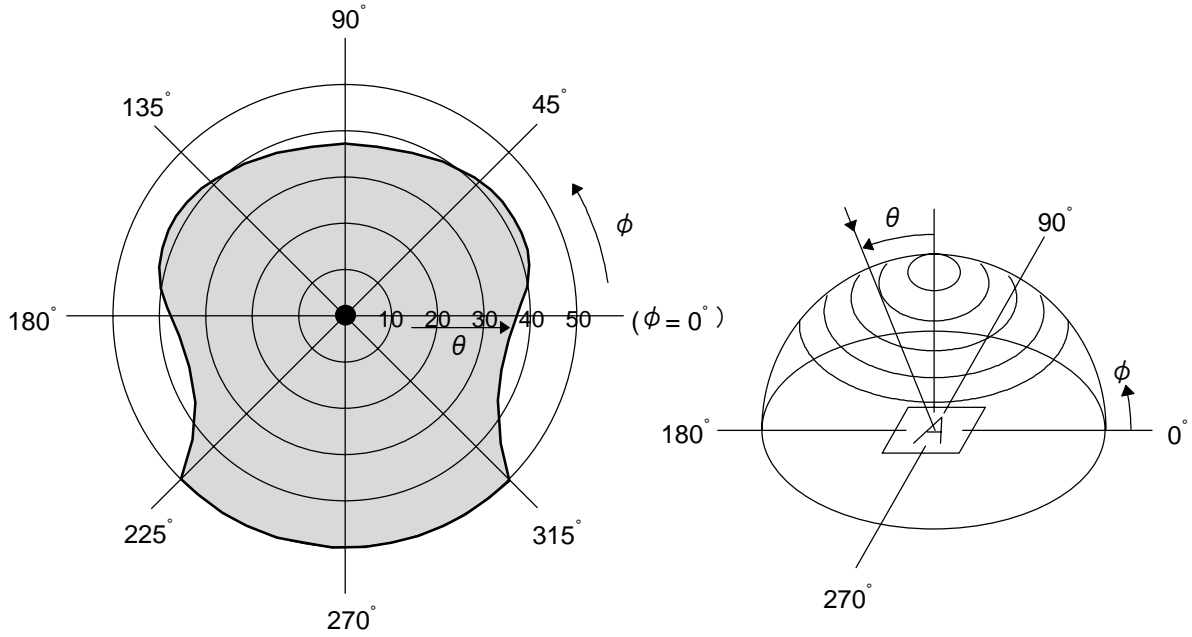

• Area  shows typ. $CR \geq 2$

3.4. System Block Diagram

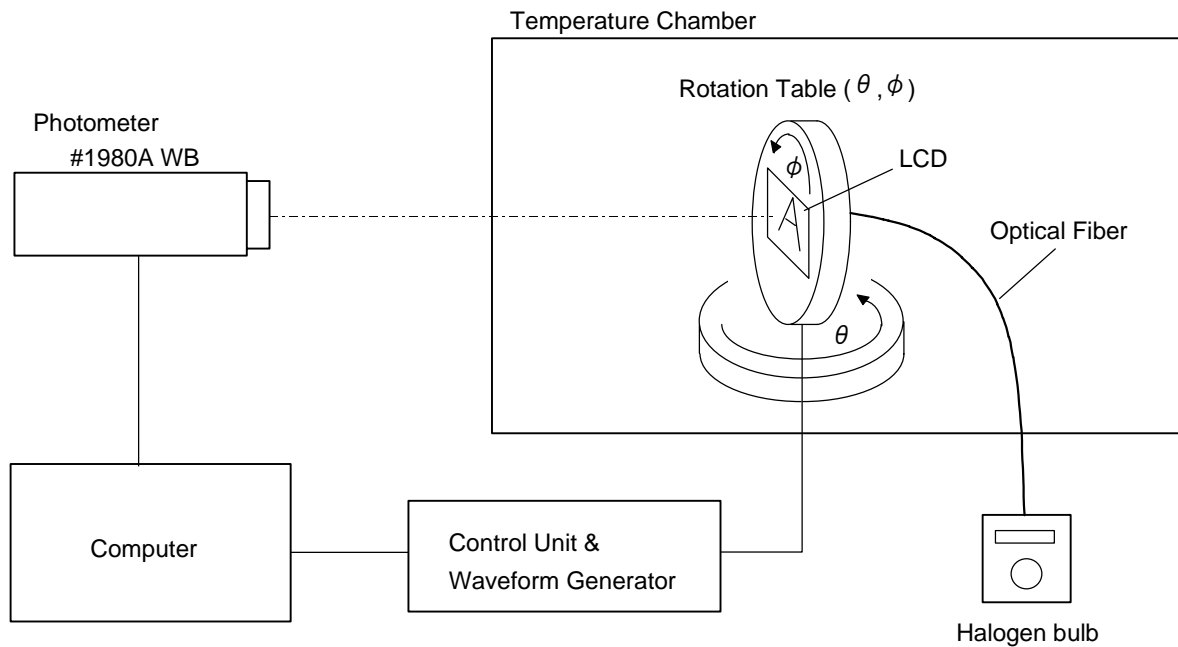

4. I/O Terminal

4.1. Pin Assignment

| No. | Symbol | Level | Function |
|-----|-----------------|--------|---|
| 1 | V _{SS} | — | Power Supply (0V, GND) |
| 2 | V _{CC} | — | Power Supply for Logic |
| 3 | V _{EE} | — | Power Supply for LCD Drive |
| 4 | RS | H / L | Register Select Signal |
| 5 | R/W | H / L | Read/Write Select Signal H : Read L : Write |
| 6 | E | H, H→L | Enable Signal (No pull-up Resister) |
| 7 | DB0 | H / L | Data Bus Line / Non-connection at 4-bit operation |
| 8 | DB1 | H / L | Data Bus Line / Non-connection at 4-bit operation |
| 9 | DB2 | H / L | Data Bus Line / Non-connection at 4-bit operation |
| 10 | DB3 | H / L | Data Bus Line / Non-connection at 4-bit operation |
| 11 | DB4 | H / L | Data Bus Line |
| 12 | DB5 | H / L | Data Bus Line |
| 13 | DB6 | H / L | Data Bus Line |
| 14 | DB7 | H / L | Data Bus Line |
| 15 | LED CATHODE | — | LED Cathode Terminal |
| 16 | LED ANODE | — | LED Anode Terminal |

4.2. Example of Power Supply

It is recommended to apply a potentiometer for the contrast adjust due to the tolerance of the driving voltage and its temperature dependence.

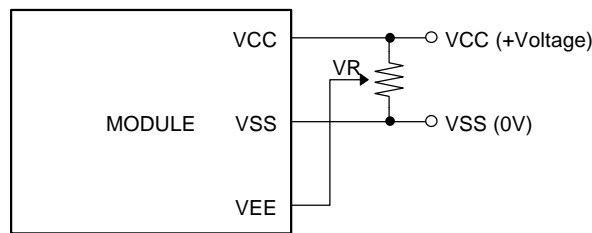

VR=10~20K Ω

4.3. Block Diagram

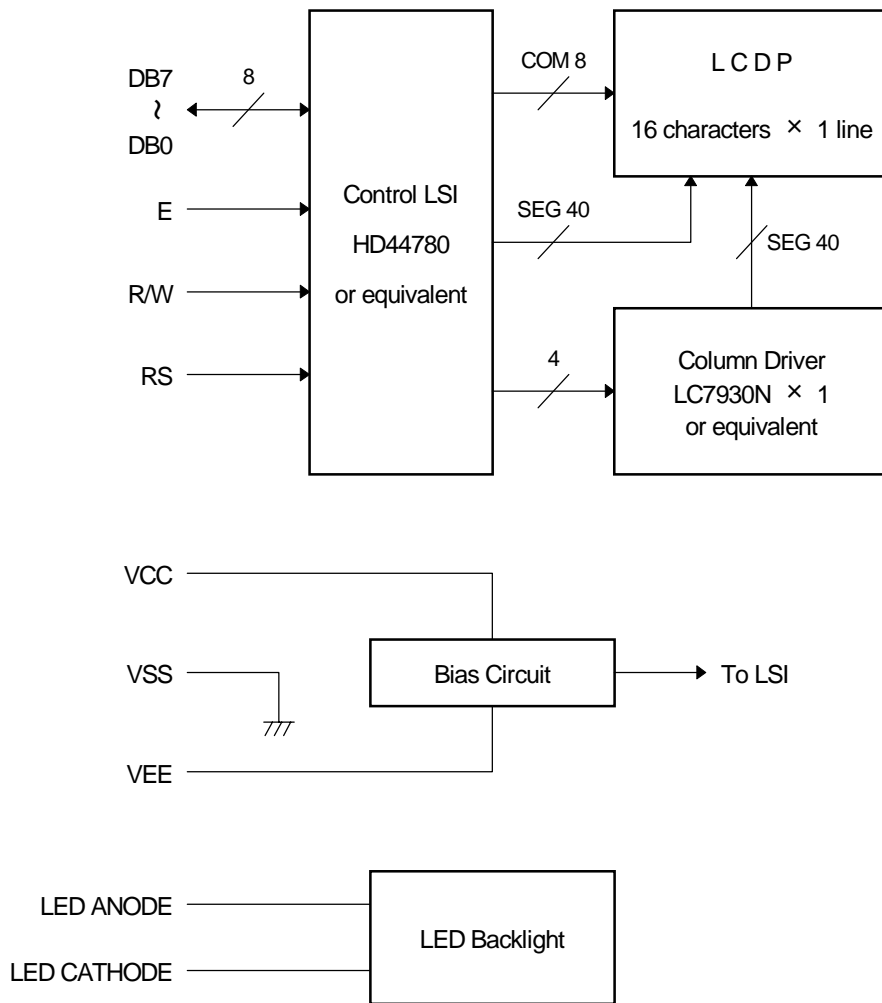

5. Test

No change on display and in operation under the following test condition.

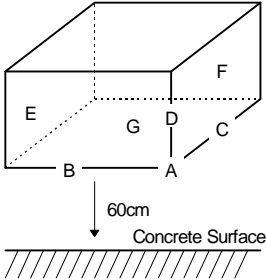
| No. | Parameter | Conditions | Notes |
|-----|----------------------------|--|-------|
| 1 | High Temperature Operating | 50°C ± 2°C, 96hrs (operation state) | |
| 2 | Low Temperature Operating | 0°C ± 2°C, 96hrs (operation state) | 3 |
| 3 | High Temperature Storage | 70°C ± 2°C, 96hrs | 4 |
| 4 | Low Temperature Storage | -20°C ± 2°C, 96hrs | 3, 4 |
| 5 | Damp Proof Test | 40°C ± 2°C, 90~95% RH, 96hrs | 3, 4 |
| 6 | Vibration Test | Total fixed amplitude : 1.5mm Vibration Frequency : 10~55Hz One cycle 60 seconds to 3 directions of X, Y, Z for each 15 minutes | 5 |
| 7 | Shock Test | To be measured after dropping from 60cm high on the concrete surface in packing state.  | |

Note 1 : Unless otherwise specified, tests will be conducted under the following condition.

Temperature : 20 ± 5°C

Humidity : 65 ± 5%

Note 2 : Unless otherwise specified, tests will be not conducted under functioning state.

Note 3 : No dew condensation to be observed.

Note 4 : The function test shall be conducted after 4 hours storage at the normal temperature and humidity after removed from the test chamber.

Note 5 : Vibration test will be conducted to the product itself without putting it in a container.

6. Appearance Standards

6.1. Inspection conditions

The LCD shall be inspected under 40W white fluorescent light.

The distance between the eyes and the sample shall be more than 30cm.

All directions for inspecting the sample should be within 45° against perpendicular line.



6.2. Definition of applicable Zones

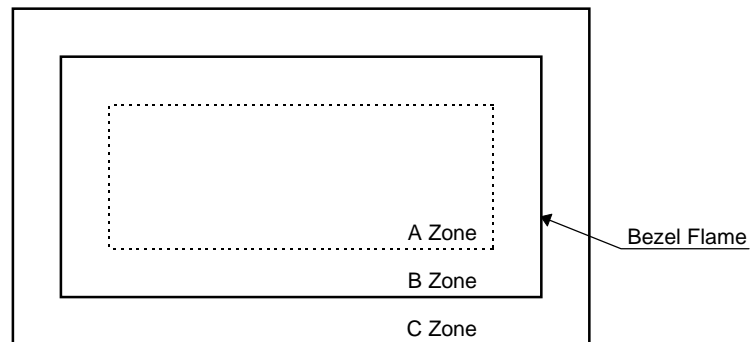

A Zone : Active display area

B Zone : Area from outside of "A Zone" to validity viewing area

C Zone : Rest parts

A Zone + B Zone = Validity viewing area

6.3.Standards

| No. | Parameter | Criteria | | | | | | | | | | | | | | | | | | | | | | | | | | | | | | | | | | | | | | | | | | | | | | | | | | | | | | | | | | |
|-----------------------|---|--|-----------------------|-------------------|--|--|---|---|---|---------------|---|---|---|---------------------|---|---|---|--------------------|---|---|---|--------------------|---|---|---|----------------------|--|-------------------|--|--|--|--|---|---|---|---|---------------|---|---|---|--------------|---------------|---|---|---|--------------|---------------|---|---|---|--------------|---------------|---|---|---|---|------------|---------------------|--|--|
| 1 | Black and White Spots, Foreign Substances | <p>(1) Round Shape</p> <table border="1"> <thead> <tr> <th rowspan="2">Dimension (mm) \ Zone</th> <th colspan="3">Acceptable Number</th> </tr> <tr> <th>A</th> <th>B</th> <th>C</th> </tr> </thead> <tbody> <tr> <td>$D \leq 0.1$</td> <td>*</td> <td>*</td> <td>*</td> </tr> <tr> <td>$0.1 < D \leq 0.2$</td> <td>5</td> <td>5</td> <td>*</td> </tr> <tr> <td>$0.2 < D \leq 0.3$</td> <td>0</td> <td>1</td> <td>*</td> </tr> <tr> <td>$0.3 < D$</td> <td>0</td> <td>0</td> <td>*</td> </tr> </tbody> </table> <p>$D = (Long + Short) / 2$ * : Disregard</p> <p>(2) Line Shape</p> <table border="1"> <thead> <tr> <th colspan="2">X(mm) \ Y(mm) \ Zone</th> <th colspan="3">Acceptable Number</th> </tr> <tr> <th colspan="2"></th> <th>A</th> <th>B</th> <th>C</th> </tr> </thead> <tbody> <tr> <td>—</td> <td>$0.02 \geq W$</td> <td>*</td> <td>*</td> <td>*</td> </tr> <tr> <td>$2.0 \geq L$</td> <td>$0.03 \geq W$</td> <td>3</td> <td>3</td> <td>*</td> </tr> <tr> <td>$1.0 \geq L$</td> <td>$0.04 \geq W$</td> <td>1</td> <td>2</td> <td>*</td> </tr> <tr> <td>$1.0 \geq L$</td> <td>$0.05 \geq W$</td> <td>0</td> <td>2</td> <td>*</td> </tr> <tr> <td>—</td> <td>$0.05 < W$</td> <td colspan="3">In the same way (1)</td> </tr> </tbody> </table> <p>X : Length Y : Width * : Disregard</p> <p>Total defects shall not exceed 5.</p> | Dimension (mm) \ Zone | Acceptable Number | | | A | B | C | $D \leq 0.1$ | * | * | * | $0.1 < D \leq 0.2$ | 5 | 5 | * | $0.2 < D \leq 0.3$ | 0 | 1 | * | $0.3 < D$ | 0 | 0 | * | X(mm) \ Y(mm) \ Zone | | Acceptable Number | | | | | A | B | C | — | $0.02 \geq W$ | * | * | * | $2.0 \geq L$ | $0.03 \geq W$ | 3 | 3 | * | $1.0 \geq L$ | $0.04 \geq W$ | 1 | 2 | * | $1.0 \geq L$ | $0.05 \geq W$ | 0 | 2 | * | — | $0.05 < W$ | In the same way (1) | | |
| Dimension (mm) \ Zone | Acceptable Number | | | | | | | | | | | | | | | | | | | | | | | | | | | | | | | | | | | | | | | | | | | | | | | | | | | | | | | | | | | |
| | A | B | C | | | | | | | | | | | | | | | | | | | | | | | | | | | | | | | | | | | | | | | | | | | | | | | | | | | | | | | | | |
| $D \leq 0.1$ | * | * | * | | | | | | | | | | | | | | | | | | | | | | | | | | | | | | | | | | | | | | | | | | | | | | | | | | | | | | | | | |
| $0.1 < D \leq 0.2$ | 5 | 5 | * | | | | | | | | | | | | | | | | | | | | | | | | | | | | | | | | | | | | | | | | | | | | | | | | | | | | | | | | | |
| $0.2 < D \leq 0.3$ | 0 | 1 | * | | | | | | | | | | | | | | | | | | | | | | | | | | | | | | | | | | | | | | | | | | | | | | | | | | | | | | | | | |
| $0.3 < D$ | 0 | 0 | * | | | | | | | | | | | | | | | | | | | | | | | | | | | | | | | | | | | | | | | | | | | | | | | | | | | | | | | | | |
| X(mm) \ Y(mm) \ Zone | | Acceptable Number | | | | | | | | | | | | | | | | | | | | | | | | | | | | | | | | | | | | | | | | | | | | | | | | | | | | | | | | | | |
| | | A | B | C | | | | | | | | | | | | | | | | | | | | | | | | | | | | | | | | | | | | | | | | | | | | | | | | | | | | | | | | |
| — | $0.02 \geq W$ | * | * | * | | | | | | | | | | | | | | | | | | | | | | | | | | | | | | | | | | | | | | | | | | | | | | | | | | | | | | | | |
| $2.0 \geq L$ | $0.03 \geq W$ | 3 | 3 | * | | | | | | | | | | | | | | | | | | | | | | | | | | | | | | | | | | | | | | | | | | | | | | | | | | | | | | | | |
| $1.0 \geq L$ | $0.04 \geq W$ | 1 | 2 | * | | | | | | | | | | | | | | | | | | | | | | | | | | | | | | | | | | | | | | | | | | | | | | | | | | | | | | | | |
| $1.0 \geq L$ | $0.05 \geq W$ | 0 | 2 | * | | | | | | | | | | | | | | | | | | | | | | | | | | | | | | | | | | | | | | | | | | | | | | | | | | | | | | | | |
| — | $0.05 < W$ | In the same way (1) | | | | | | | | | | | | | | | | | | | | | | | | | | | | | | | | | | | | | | | | | | | | | | | | | | | | | | | | | | |
| 2 | Air Bubbles (between glass & polarizer) | <table border="1"> <thead> <tr> <th rowspan="2">Dimension (mm) \ Zone</th> <th colspan="3">Acceptable Number</th> </tr> <tr> <th>A</th> <th>B</th> <th>C</th> </tr> </thead> <tbody> <tr> <td>$D \leq 0.15$</td> <td>*</td> <td>*</td> <td>*</td> </tr> <tr> <td>$0.15 < D \leq 0.3$</td> <td>2</td> <td>3</td> <td>*</td> </tr> <tr> <td>$0.3 < D \leq 0.5$</td> <td>1</td> <td>2</td> <td>*</td> </tr> <tr> <td>$0.5 < D \leq 1.0$</td> <td>0</td> <td>1</td> <td>*</td> </tr> </tbody> </table> <p>* : Disregard</p> <p>Total defects shall not exceed 3.</p> | Dimension (mm) \ Zone | Acceptable Number | | | A | B | C | $D \leq 0.15$ | * | * | * | $0.15 < D \leq 0.3$ | 2 | 3 | * | $0.3 < D \leq 0.5$ | 1 | 2 | * | $0.5 < D \leq 1.0$ | 0 | 1 | * | | | | | | | | | | | | | | | | | | | | | | | | | | | | | | | | | | | |
| Dimension (mm) \ Zone | Acceptable Number | | | | | | | | | | | | | | | | | | | | | | | | | | | | | | | | | | | | | | | | | | | | | | | | | | | | | | | | | | | |
| | A | B | C | | | | | | | | | | | | | | | | | | | | | | | | | | | | | | | | | | | | | | | | | | | | | | | | | | | | | | | | | |
| $D \leq 0.15$ | * | * | * | | | | | | | | | | | | | | | | | | | | | | | | | | | | | | | | | | | | | | | | | | | | | | | | | | | | | | | | | |
| $0.15 < D \leq 0.3$ | 2 | 3 | * | | | | | | | | | | | | | | | | | | | | | | | | | | | | | | | | | | | | | | | | | | | | | | | | | | | | | | | | | |
| $0.3 < D \leq 0.5$ | 1 | 2 | * | | | | | | | | | | | | | | | | | | | | | | | | | | | | | | | | | | | | | | | | | | | | | | | | | | | | | | | | | |
| $0.5 < D \leq 1.0$ | 0 | 1 | * | | | | | | | | | | | | | | | | | | | | | | | | | | | | | | | | | | | | | | | | | | | | | | | | | | | | | | | | | |

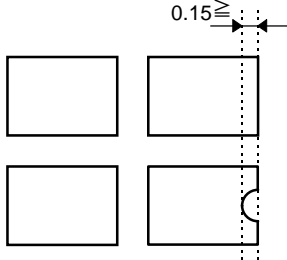
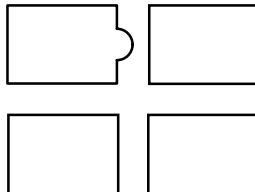
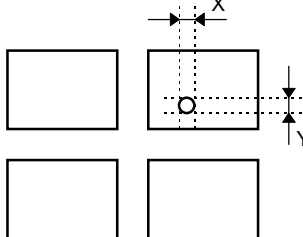

| No. | Parameter | Criteria |
|-----|---------------------|---|
| 3 | The Shape of Dot | <p>(1) Dot Shape (with Dent)</p>  <p>As per the sketch of left hand.</p> <p>(2) Dot Shape (with Projection)</p>  <p>Should not be connected to next dot.</p> <p>(3) Pin Hole</p>  <p>$(X+Y) / 2 \leq 0.2\text{mm}$ (Less than 0.1mm is no counted.)</p> <p>Total defects shall not exceed 5.</p> |
| 4 | Polarizer Scratches | Not to be conspicuous defects. |
| 5 | Polarizer Dirts | If the stains are removed easily from LCDP surface, the module is not defective. |
| 6 | Color Variation | Not to be conspicuous defects. |

7. Code System of Production Lot

The production lot of module is specified as follows :

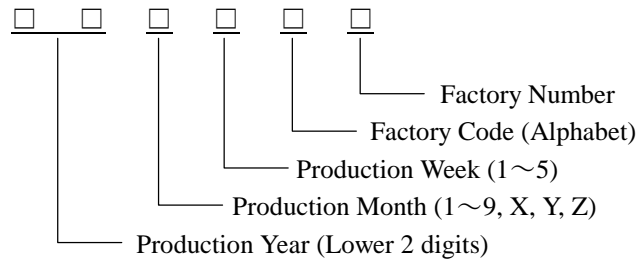

8. Type Number

The type number of module is specified on the back of module as follows :

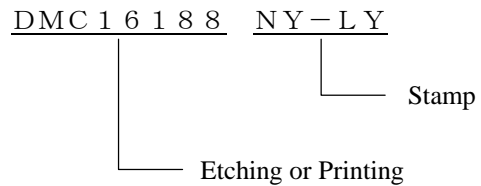

9. Applying Precautions

Please contact us when questions and/or new problems not specified in this specifications arise.

10. Handling Precautions

Optrex Products are designed for use in ordinary electronic devices such as business machines, telecommunications equipment, measurement devices and etc..

Optrex Products are not designed, intended, or authorized for use in any application in which the failure of the product could result in a situation where personal injury or death may occur. These applications include, but are not limited to, life-sustaining equipment, nuclear control devices, aerospace equipment, devices related to hazardous or flammable materials, etc. (If Buyer intends to purchase or use the Optrex Products for such unintended or unauthorized applications, Buyer must secure prior written consent to such use by a responsible officer of Optrex Corporation.) Should Buyer purchase or use Optrex Products for any such unintended or unauthorized application (without such consent), Buyer shall indemnify and hold Optrex and its officers, employees, subsidiaries, affiliates and distributors harmless against all claims, costs, damages and expenses, and reasonable attorney's fees, arising out of, directly or indirectly, any claim of personal injury or death associated with such unintended or unauthorized use, even if such claim alleges that Optrex was negligent regarding the design or manufacture of the part.

- 1) LCD may be broken because it is made of glass.
- 2) Polarizer is a soft material and can easily be scratched.
- 3) Please avoid static electricity.
 - ① Please be sure to ground human body and electric appliances during work.
 - ② It is preferable to use conductive mat on table and wear cotton clothes or conduction processed fiber. Synthetic fiber is not recommended.
 - ③ Please slowly peel off protective film, because static electricity may be charged.
- 4) If it is necessary to store LCD modules for a long time, please comply with the following procedures. If storage condition is not satisfactory, display (especially polarizer) may be deteriorated or soldering I/O terminals may become difficult (some oxide is generated at I/O terminals plating).
 - ① Store as delivered by Optrex
 - ② If you store as unpacked, put in anti-static bag, seal its opening and store where it is not subjected to direct sunshine nor fluorescent lamp.
 - ③ Store at temperature 0 to +35°C and at low humidity. Please refer to our specification sheets for storage temperature range and humidity condition.
- 5) The module does not contain excess current limiter.
Please design the limiter to cut excess current in your power supply circuit.
- 6) Liquid crystal may be leaked when display is broken. Never taste it. If your hands or clothes touch it, please immediately wash using soap.
- 7) The connection between the bezel and Vss (GND) is not specified in the module.
(Some module do not maintain connection between them.)
Please consult OPTREX to specify the connection.

Optrex shall not be responsible for any infringement of industrial property rights of third parties in any country arising out of the application or use of Optrex Products, except which directly concern the structure or production of such products.